

2A STEP-DOWN PWM CONVERTER

FEATURES

- Operating Input Voltage From 4.5V to 30V
- 3.3V, 5V, 12V and Adjustable Output Version
- Adjustable Version Output Voltage Range, 1.8V to 30V \pm 4% max Over Line and Load Regulation
- Available in SOP-8 and TO-252-5 Package
- Requires Only 4 External Components.
- 150KHz Fixed Constant Frequency
- Low Power Standby Mode, I_Q Typically 80 μ A
- TTL Shutdown Capability.
- Output Overvoltage Protection
- Current Limit and Thermal Shutdown Protection.
- 2A Guaranteed Output Load Current

APPLICATIONS

- Fixed Voltage power supply for LCD Monitor and LCD TV
- On-Card Switching regulators
- Simple High Efficiency Step-down regulator

TYPICAL APPLICATION CIRCUIT

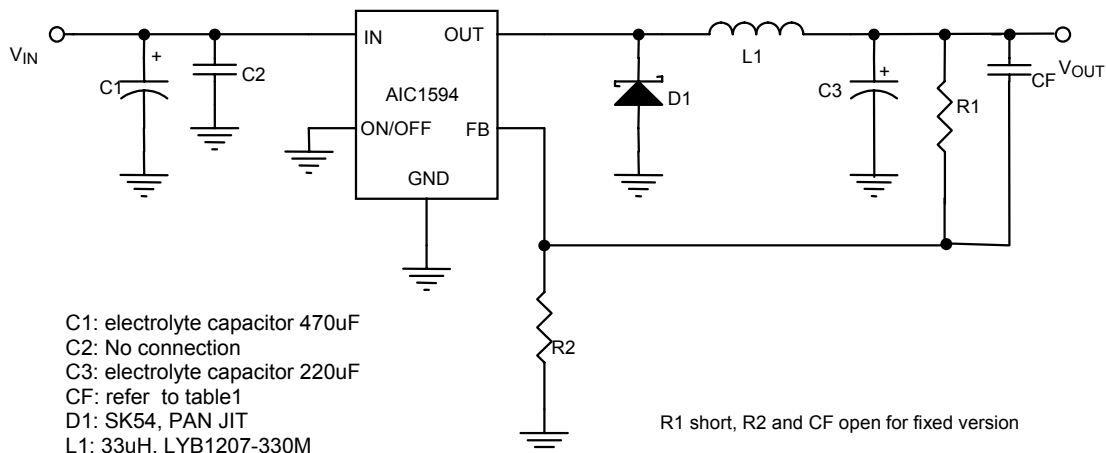

2A Precision PWM DC/DC Converter

GENERAL DESCRIPTION

The AIC1594 series are step-down monolithic PWM converters for delivering 2A at fixed voltages of 3.3V, 5.0V, 12V and using an external divider to adjust output voltage from 1.8V to 30V with excellent line and load regulation.

Switching frequency up to 150KHz is achievable thus allowing smaller-sized filter components. Internal current limit and thermal shutdown circuits provide protection from overloads. It also provides output overvoltage and short protection under fault conditions. The internal precise reference combined with voltage feedback loop provides optimum output voltage accuracy and fast load transient response.

ORDERING INFORMATION

AIC1594-XXXXXXXX

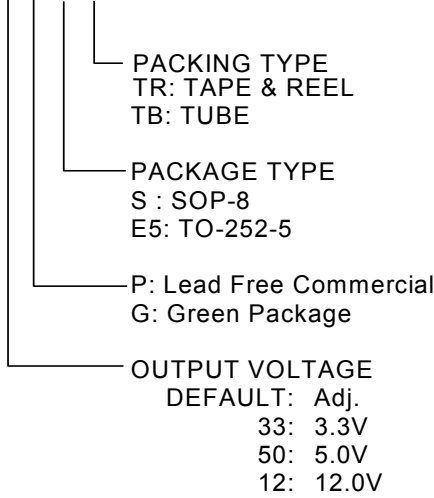

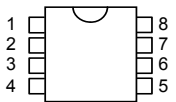
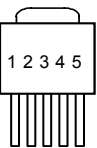
ORDER NUMBER	PIN CONFIGURATION
AIC1594PS AIC1594-33PS AIC1594-50PS AIC1594-12PS	SOP-8 FRONT VIEW 1: IN 2. OUT 3. FB 4. ON/OFF 5. GND 6. GND 7. GND 8. GND 
AIC1594PE5 AIC1594-33PE5 AIC1594-50PE5 AIC1594-12PE5	TO-252-5 FRONT VIEW 1: IN 2. OUT 3. GND 4. FB 5. ON/OFF 

Example: AIC1594-50PSTR

→ 5.0V Output Version, in Lead Free SOP-8 Package & Taping & Reel
Packing Type

AIC1594-33PE5TR

→ 3.3V Output Version, in Lead Free TO-252-5 Package & Taping & Reel
Packing Type

ABSOLUTE MAXIMUM RATINGS

Supply Voltage	30V
FB, ON/OFF Pin Input Voltage	-0.3V to +30V
Operating Temperature Range	-40°C ~ 85°C
Storage Temperature Range	-65°C ~ 150°C
Junction Temperature	125°C
Lead Temperature (Soldering 10s)	260°C
Thermal Resistance Junction to Case	TO-252-5	12.5°C /W
	SOP-8	40°C /W
Thermal Resistance Junction to Ambient	TO-252-5	100°C /W
(Assume no ambient airflow, no heatsink)	SOP-8	160°C /W

Absolute Maximum Ratings are those values beyond which the life of a device may be impaired.

■ TEST CIRCUIT

Refer to Typical Application Circuit.

■ ELECTRICAL CHARACTERISTICS ($T_A=25^\circ\text{C}$, $V_{IN}=12\text{V}$ for the 3.3V, 5V and Adjustable version and $V_{IN}=24\text{V}$ for the 12V version.) (Note1)

PARAMETER	TEST CONDITIONS	MIN.	TYP.	MAX.	UNIT
Input Voltage		4.5		30	V
Fixed Output Voltage	AIC1594-33 ($V_{IN} > 4.75\text{V}$)	3.168		3.432	V
	AIC1594-50 ($V_{IN} > 7.0\text{V}$)	4.800		5.200	V
	AIC1594-12 ($V_{IN} > 15\text{V}$)	11.52		12.48	V
FB Reference Voltage		1.193		1.267	V
Saturation Voltage			1.2	1.4	V
Output Voltage Regulation				4	%
Quiescent Current	Internal switch off		5	10	mA
Shutdown Quiescent Current	ON/OFF= 5V (OFF)		80	200	μA
FB bias current	$V_{FB}=1.3$		10	50	nA
Output leakage current	$V_{out}=-0.9$		2	30	mA
Logic Input High	(Regulator OFF)	2.0			V
Logic Input Low	(Regulator ON)			0.6	V
Oscillator Frequency		130	150	180	KHz
Output Current Limit		3.0		6.9	A
Over Voltage Protection			120		%
Maximum Duty Cycle		100			%
Minimum Duty Cycle			0		%
Efficiency	$V_o=5\text{V}$, $I_o=2\text{A}$		80		%

Note 1: Specifications are production tested at $T_A=25^\circ\text{C}$. Specifications over the -40°C to 85°C operating temperature range are assured by design, characterization and correlation with Statistical Quality Controls (SQC).

TYPICAL PERFORMANCE CHARACTERISTICS

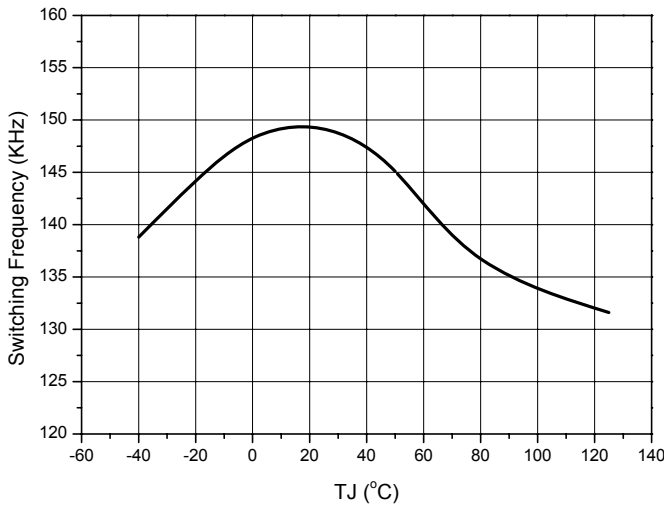

Fig.1 Switching Frequency vs. Temperature

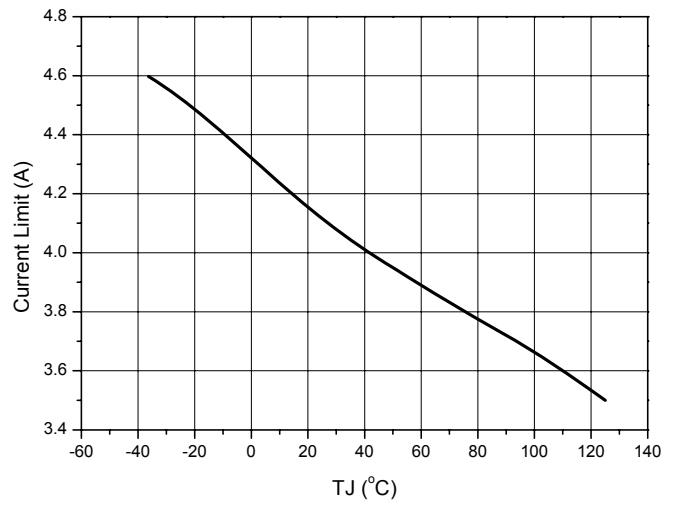

Fig.2 Current Limit vs. Temperature

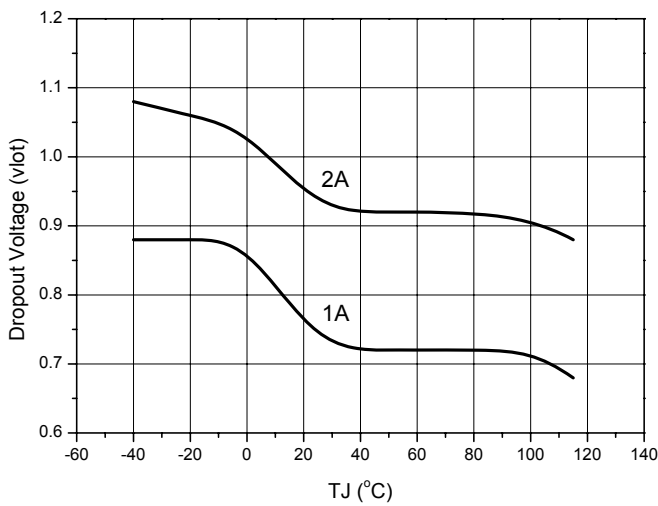

Fig.3 Dropout Voltage vs. Temperature

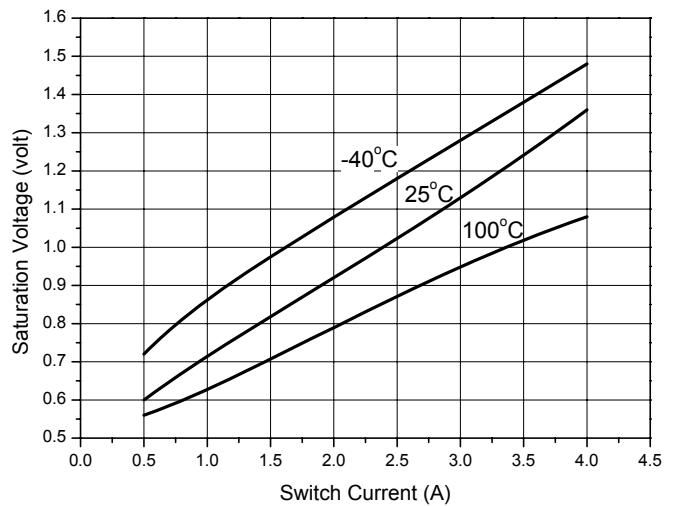

Fig.4 Switching Saturation Voltage vs. Switch Current

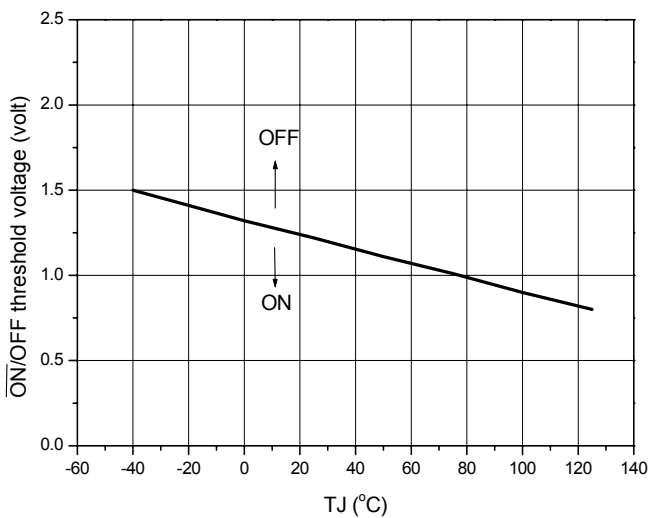

Fig.5 ON/OFF Threshold Voltage vs. Temperature

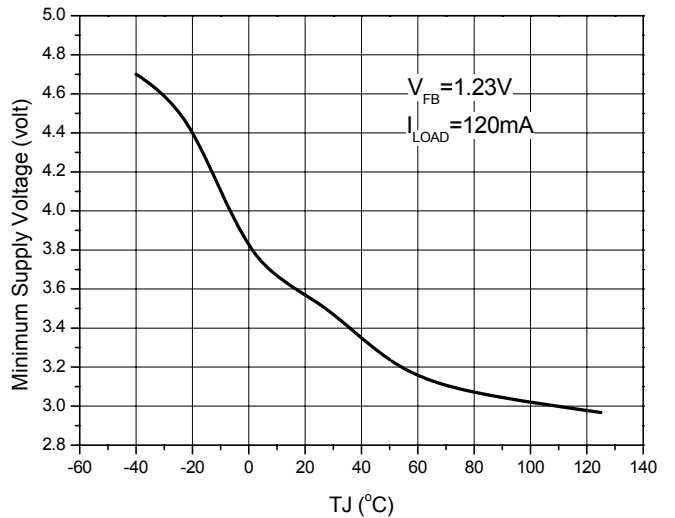

Fig.6 Minimum Operating Supply Voltage vs. Temperature (ADJ only)

TYPICAL PERFORMANCE CHARACTERISTICS (Continued)

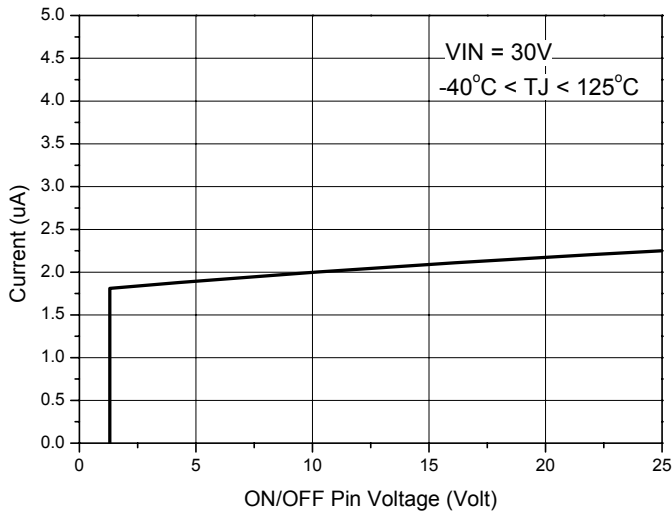

Fig.7 ON/OFF Pin Current (sinking) vs. Temperature

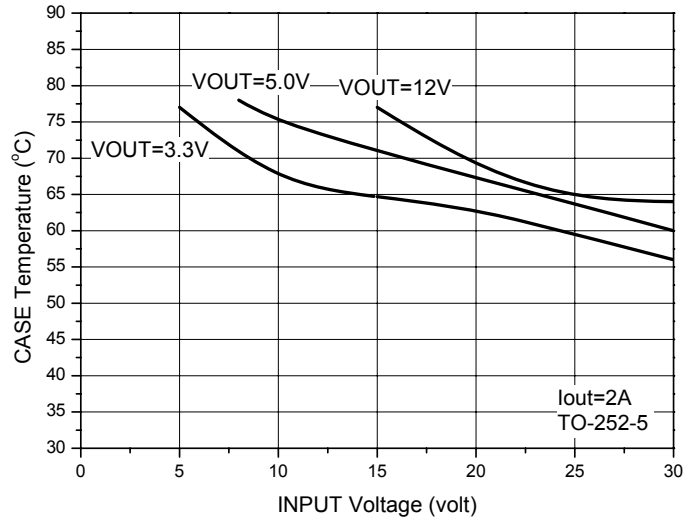

Fig.8 Case Temperature vs. Input Voltage

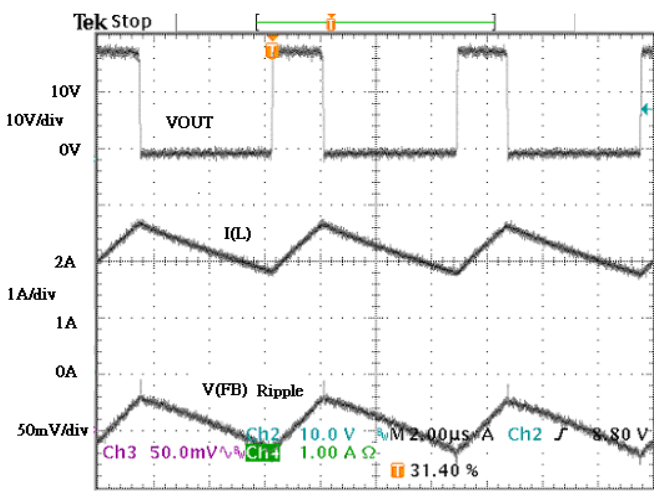

Fig.9 FB Pin Rip-

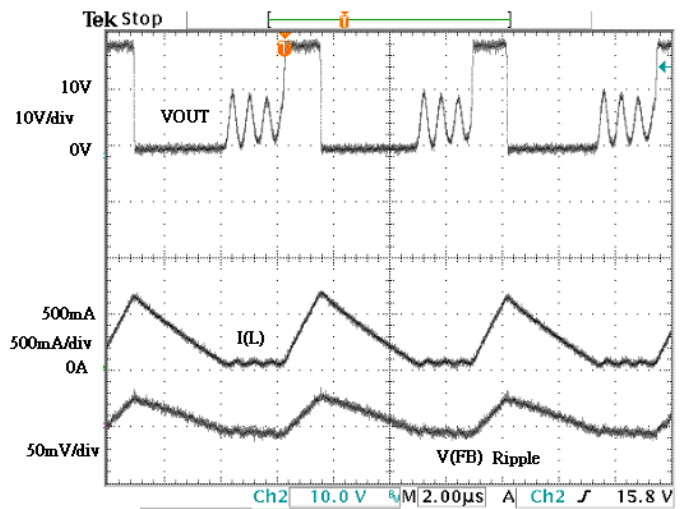

Fig.10 FB Pin Ripple(DCM)

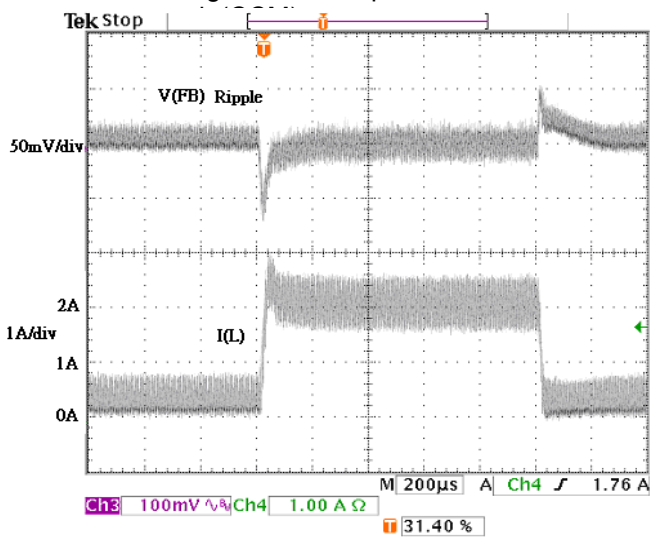

Fig.11 Load Transient Response

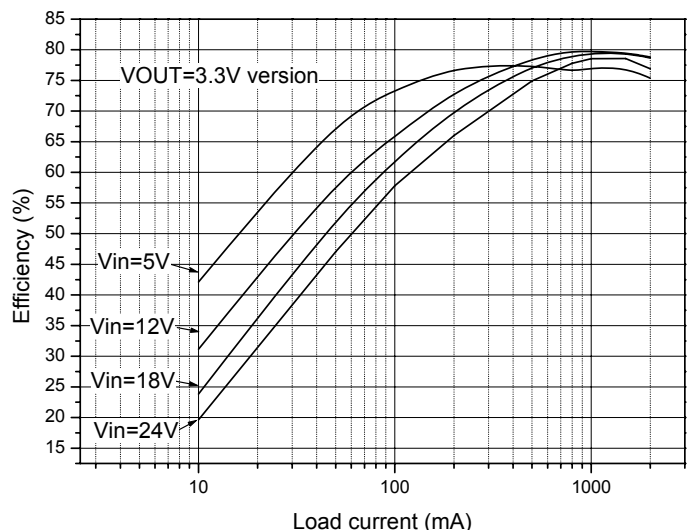

Fig.12 3.3V Version Efficiency

TYPICAL PERFORMANCE CHARACTERISTICS (Continued)

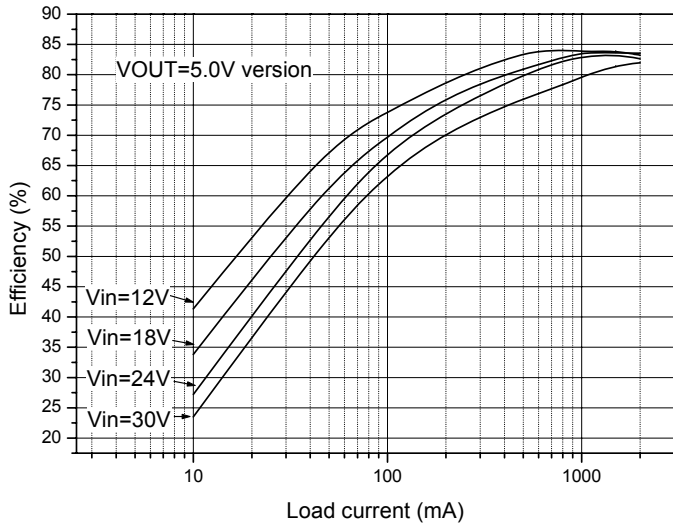

Fig.13 5V Version Efficiency

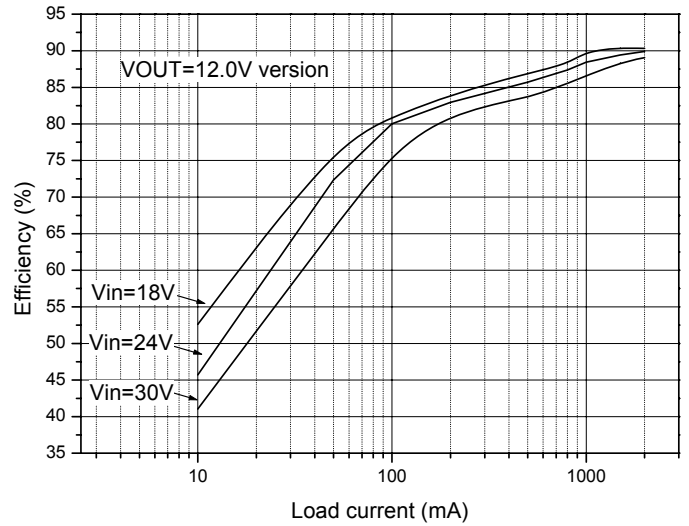
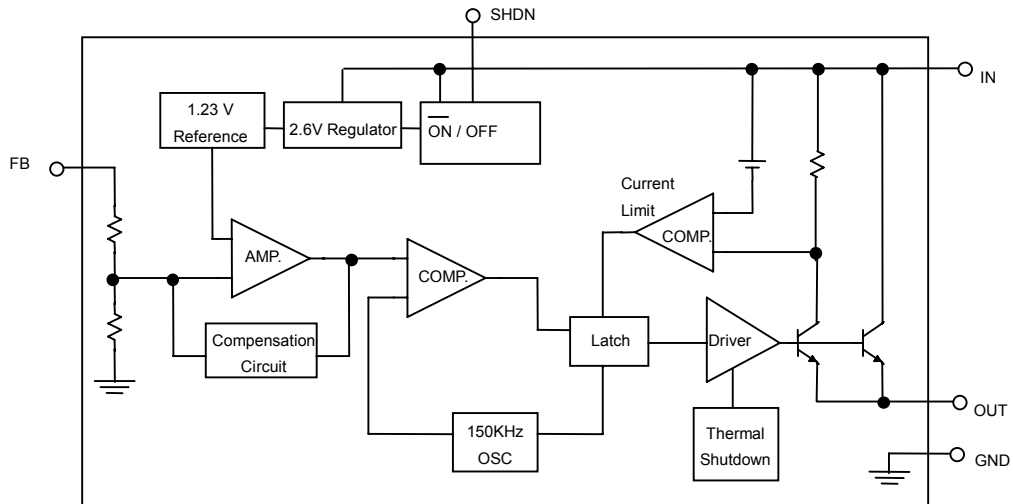

Fig.14 12V Version Efficiency

BLOCK DIAGRAM



■ PIN DESCRIPTIONS

- IN PIN: Supply voltage input for the IC switching regulator. A suitable input bypass capacitor must be present at this pin to minimize voltage transients and to supply the switching currents needed by the regulator.
- OUT PIN: Internal switch. The voltage at this pin switches between $(V_{IN}-V_{SAT})$ and approximately $-0.5V$, with a duty cycle of approximately V_{OUT}/V_{IN} .
- GND PIN: Ground requires a short, low noise connection to ensure good load regulation.
- FB PIN: Feedback input for fixed-output or adjustable-output version. Connect directly to output for fixed operation version or to a resistor divider for adjustable operation versions.
- \overline{ON}/OFF PIN: Allows the switching regulator circuit to be shutdown using logic level signals thus dropping the total input supply current to approximately $80\mu A$. Drive it high to disable the reference, control circuitry and internal switches. Drive low or connect to GND for normal operation.

■ APPLICATION INFORMATION

Thermal considerations

The AIC1594 is available with SOP-8 and TO-252-5 package. The SOP-8 and TO-252-5 packages are designed to be soldered to the copper on a printed circuit board. The printed circuit board is the heat sink for SOP-8 and TO-252-5 package and other heat components, such as inductors and diodes. The size of the heat sink depends on the power loss of AIC1594 and the ambient temperature. The power loss of AIC1594 is determined by input voltage, output voltage and load current. The Fig.8 represents the curve of the AIC1594 case temperature in different conditions.

The curve shows the AIC1594 temperature rises above ambient temperature for a 2A load with different input and output voltage. The values of the temperature rise, which are

affected by factors such as sink size, heat produced from heat components, and etc., may be different from those in Fig.8 depending on the conditions of the application. According to the equation 1, as the power loss or ambient temperature is rising the heat sink size must be increased to decrease the thermal resistance ($R\theta_{jA}$) so that the junction temperature does not over 125 C . An appropriate increase of heat sink size may result in a normal-ranged junction temperature.

$$P_D = \frac{T_j - T_A}{R\theta_{jA}} \text{-----(1)}$$

As junction temperature rises to its temperature protect point, the AIC1594 will stop working. Output voltage drops to zero until the junction temperature decreases to a normal range.

■ APPLICATION INFORMATION (Continued)

Components Selection

Inductor

The inductor selection depends on the operating frequency of the AIC1594. The ripple current ΔI_L interrelates with inductor value. A lower inductor value gets a higher ripple current. Besides, a higher V_{IN} or V_{OUT} can also get the same result. The inductor value can be calculated as the following formula.

$$L \geq \frac{1}{(f)(\Delta I_L)} V_{OUT} \left(1 - \frac{V_{OUT}}{V_{IN}} \right) \text{-----(2)}$$

Users can define the acceptable ΔI_L to gain a suitable inductor value.

Capacitor

The selection of output capacitor depends on the suitable ripple voltage. Lower ripple voltage corresponds to lower ESR (Equivalent Series Resistor) of output capacitor. Typically, once the ESR is satisfied with the ripple voltage, the value of capacitor is adequate for filtering. The formula of ripple voltage is as below:

$$\Delta V_{OUT} = \Delta I_L \left(ESR + \frac{1}{8fC_{OUT}} \right) \text{-----(3)}$$

The typical input capacitor is 470uF. But as the temperature decreases, the input capacitor needs to increase to stabilize the circuit.

Diode

The diode current rating must be higher than 1.2 times maximum load current. Also, if the power supply needs to resist a continuous output short, the diode should have a current rating equal to the maximum current limit of the AIC1594. The reverse voltage rating of the diode should be higher than 1.2 times input

voltage and the diode must be fast. The reverse recovery time of the diode is short.

Example

Assume the input voltage is 12V, output voltage is 5V and maximum load current is 2A. The output ripple must be smaller than 2% of output voltage

Inductor selection

$$L \geq \frac{1}{(f)(\Delta I_L)} V_{OUT} \left(1 - \frac{V_{OUT}}{V_{IN}} \right) \\ = \frac{1}{150k \times 0.4} \times 5 \times \left(1 - \frac{5}{12} \right) = 48.5\mu H$$

Here, the ΔI_L is 0.4A. So we choose 56uH inductor.

Output capacitor selection

$$\Delta V_{OUT} = \Delta I_L \left(ESR + \frac{1}{8fC_{OUT}} \right) < 100mV$$

We choose the capacitor value: ESR=0.12, capacitance=220uF

$$\Rightarrow \Delta V_{OUT} = \Delta I_L \left(ESR + \frac{1}{8fC_{OUT}} \right) = 74mV$$

The full load is 2A and ΔI_L is 0.4A, so the diode current rating must be higher than 2.4A.

CF Capacitor for adj version

As using the AIC1594 adj version, the CF capacitor is required to provide additional stability. In different condition, the CF capacitor must be changed to make the circuit stable.

Output Voltage	Input Voltage	R1(Ω)	R2(Ω)	CF
1.8V	7V	36k	82k	1000pF
4V	12V	180k	82k	360pF
6V	12V	180k	47k	360pF
8V	15V	180k	33k	360pF
10V	18V	150k	22k	470pF
15V	25V	110k	10k	560pF

Table1

■ PHYSICAL DIMENSIONS (unit: mm)

- SOP-8

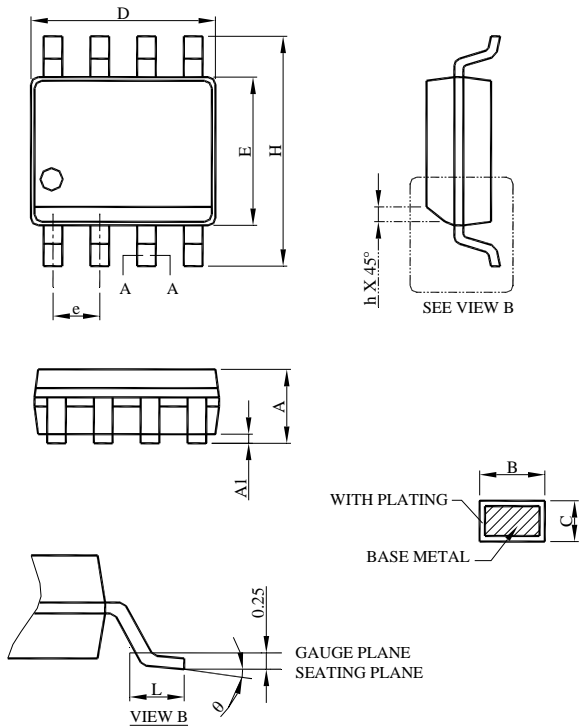

SYMBOL	SOP-8	
	MILLIMETERS	
	MIN.	MAX.
A	1.35	1.75
A1	0.10	0.25
B	0.33	0.51
C	0.19	0.25
D	4.80	5.00
E	3.80	4.00
e	1.27 BSC	
H	5.80	6.20
h	0.25	0.50
L	0.40	1.27
θ	0°	8°

- Note: 1. Refer to JEDEC MS-012AA.
- Dimension "D" does not include mold flash, protrusions or gate burrs. Mold flash, protrusion or gate burrs shall not exceed 6 mil per side .
 - Dimension "E" does not include inter-lead flash or protrusions.
 - Controlling dimension is millimeter, converted inch dimensions are not necessarily exact.

■ PHYSICAL DIMENSIONS(Continued) (unit: mm)

- TO-252-5

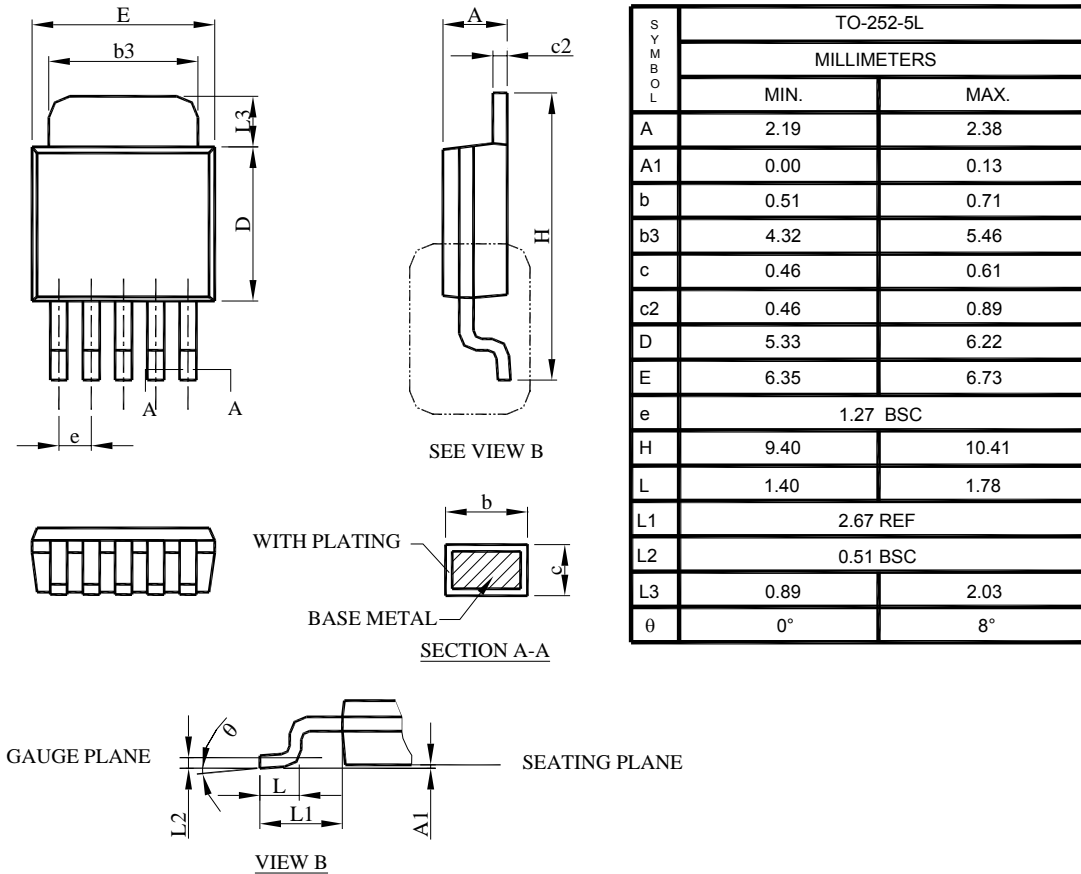

TO-252-5L		
MILLIMETERS		
SYMBOL	MIN.	MAX.
A	2.19	2.38
A1	0.00	0.13
b	0.51	0.71
b3	4.32	5.46
c	0.46	0.61
c2	0.46	0.89
D	5.33	6.22
E	6.35	6.73
e	1.27 BSC	
H	9.40	10.41
L	1.40	1.78
L1	2.67 REF	
L2	0.51 BSC	
L3	0.89	2.03
θ	0°	8°

Note:

Information provided by AIC is believed to be accurate and reliable. However, we cannot assume responsibility for use of any circuitry other than circuitry entirely embodied in an AIC product; nor for any infringement of patents or other rights of third parties that may result from its use. We reserve the right to change the circuitry and specifications without notice.

Life Support Policy: AIC does not authorize any AIC product for use in life support devices and/or systems. Life support devices or systems are devices or systems which, (i) are intended for surgical implant into the body or (ii) support or sustain life, and whose failure to perform, when properly used in accordance with instructions for use provided in the labeling, can be reasonably expected to result in a significant injury to the user.